

# Metal Shaft Potentiometer 9mm Size Metal Shaft Multi-ganged Type

RK097/RK098 Series



9.5mm width potentiometer ideal for various types of control.



## Typical Specifications

Items	Specifications
Total resistance tolerance	± 20%
Maximum operating voltage	50V AC , 10V DC
Total rotational angle	300 ± 5 ( For shaft movable type, 300 <sup>+10°</sup> <sub>-5°</sub> )
Rotational torque	2 to 25mN·m
Operating life	15,000cycles
Operating temperature range	- 20 to + 70

Rotary Potentiometers  
Slide Potentiometers

## Product Line

### Single-shaft without switch type

Number of resistor elements	Mounting direction	Shaft type	Length of the shaft (mm)	Center detent	Total resistance (k)	Resistance taper	Minimum order unit (pcs.)	Products No.	Drawing No.
Single-unit	Horizontal type	Flat	15	Without	10	15A	1,200	RK097111080J	1
					20	1B		RK0971110909	
					50	15A		RK097111050B	
				With	10	1B		RK0971110D7F	
					50	1B		RK097111020N	
					100	1B		RK09711100WY	
			20	Without	10	15A	RK097111080R		
					50	1B	RK0971110D88		
					100	1B	RK09711100F8		
				With	50	1B	RK09711100Q2		
					100	1B	RK09711100Q2		
					10	15A	RK097111091M		
25	Without	10	15A	RK097111091M					
		10	1B	RK0971110D57					

Metal Shaft  
Insulated Shaft  
Knob Operating

## Note

Products other than those listed in above products are also available. Please contact us for details.

**Product Line**

**Single-shaft without switch type**

Number of resistor elements	Mounting direction	Shaft type	Length of the shaft (mm)	Center detent	Total resistance (k)	Resistance taper	Minimum order unit (pcs.)	Products No.	Drawing No.
Dual-unit for tone	Horizontal type	Flat	20	With	20	1B	800	RK0971210Z2M	2
				Without	50			1B	
25			10		15A	RK0971210097			
					15	3B	1,200	RK09712200MC	
20			15A			800	RK09712200MY		
			3B	RK09712200HA					
	15A	RK097122008T							
	20	15A	RK09712200MT						

**Single-shaft with rotary switch type**

Number of resistor elements	Mounting direction	Shaft type	Length of the shaft (mm)	Center detent	Total resistance (k)	Resistance taper	Minimum order unit (pcs.)	Products No.	Drawing No.	
Single-unit	Horizontal type	Flat	15	Without	20	15A	700	RK0971111Z0P	3	
					50			RK0971111Z32		
			20		10	1B		RK09711110AL		
RK09711110EL										
Dual-unit for vol.			15		20	20		3B	RK0971221Z05	4
								RK0971221Z11		

**Single-shaft push-on push-off switch type**

Number of resistor elements	Mounting direction	Shaft type	Length of the shaft (mm)	Center detent	Total resistance (k)	Resistance taper	Minimum order unit (pcs.)	Products No.	Drawing No.		
Single-unit	Horizontal type	Flat	20	Without	10	15A	700	RK097111201V	5		
								25		1B	RK097111202P
			RK097111202Q								
Dual-unit for tone			15			20	50	15A	600	RK097121200C	6
								3B		RK097122200G	

**Single-shaft momentary push(0.5mm travel) switch type**

Number of resistor elements	Mounting direction	Shaft type	Length of the shaft (mm)	Center detent	Total resistance (k)	Resistance taper	Minimum order unit (pcs.)	Products No.	Drawing No.
Single-unit	Horizontal type	Flat	15	With	10	3B	700	RK0971114D0B	7
Dual-unit for tone			20	Without		1B		RK0971214Z06	8
Dual-unit for vol.						15A		RK0971224Z01	

**Note**

Products other than those listed in above products are also available. Please contact us for details.

Refer to P.333, 334, 335 for product varieties.

Rotary Potentiometers  
Slide Potentiometers

Metal Shaft  
Insulated Shaft  
Knob Operating

**Product Line**

**Single-shaft momentary push( 1.5mm travel )switch type**

Number of resistor elements	Mounting direction	Shaft type	Length of the shaft ( mm )	Center detent	Total resistance ( k )	Resistance taper	Minimum order unit ( pcs. )	Products No.	Drawing No.
Single-unit	Horizontal type	Flat	20	Without	10	1B	700	RK0971114Z07	9
			25			15A		RK0971114Z0T	

**Single-shaft with push-lock mechanism type**

Number of resistor elements	Mounting direction	Shaft type	Length of the shaft ( mm )	Center detent	Total resistance ( k )	Resistance taper	Minimum order unit ( pcs. )	Products No.	Drawing No.
Single-unit	Horizontal type	Flat	25	Without	10	1B	700	RK097111T065	10
					100	15A		RK097111TZ17	
					10	1B		RK097111T064	
				100	RK097111TD2M				
				10	RK097111TD44				
				Dual-unit for tone	Without	10		600	
Dual-unit for vol	15A	RK097122T017							
50	3B	RK097122TZ0A							

**Single-shaft, dual-unit with push-lock mechanism and pull-lock mechanism type**

Number of resistor elements	Mounting direction	Mechanism specifications	Shaft type	Length of the shaft ( mm )	Center detent	Total resistance ( k )	Resistance taper	Minimum order unit ( pcs. )	Products No.	Drawing No.
Single-unit	Horizontal type	The pull lock section The normal section	Flat	30	With	50	1B	400	RK098122TE04	12

**Dual-shaft, dual-unit without switch type**

Number of resistor elements	Mounting direction	shaft	Shaft type	Length of the shaft ( mm )	Center detent	Total resistance ( k )	Resistance taper	Minimum order unit ( pcs. )	Products No.	Drawing No.	
Single-unit	Horizontal type	The outer shaft	Slotted	10	Without	10	1B	700	RK0972210C07	13	
		The inner shaft	Flat	20			15A				
		The outer shaft	Slotted	15					15C	RK097221005C	14
		The inner shaft	Flat	25							
		The outer shaft	Slotted	15					RK097221004C		
		The inner shaft	Flat	25							

**Note**

Products other than those listed in above products are also available. Please contact us for details.







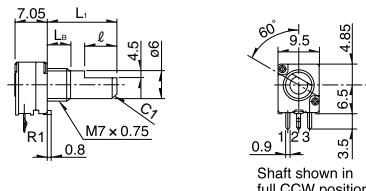
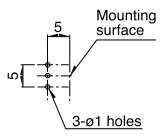

Refer to P.333, 334, 335 for product varieties.  
 Refer to P.363 for attached parts.

**Dimensions**

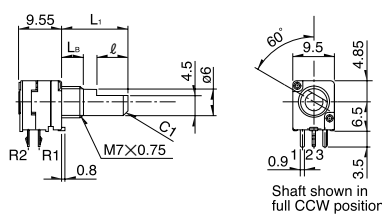
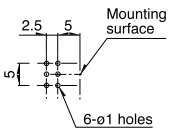
Unit:mm

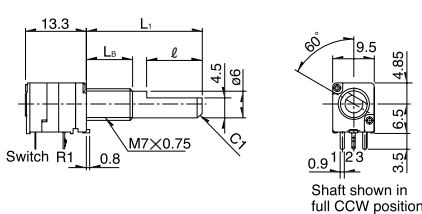
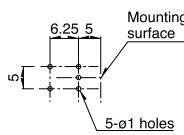

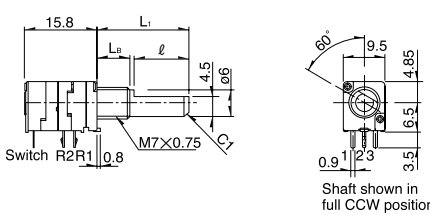
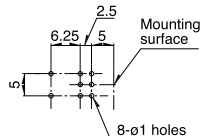



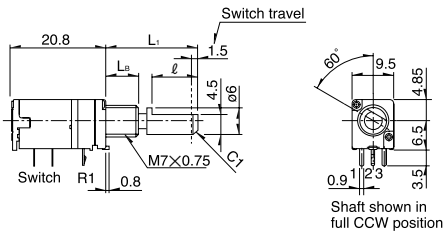
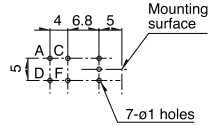

Rotary Potentiometers  
 Slide Potentiometers

Metal Shaft  
 Insulated Shaft  
 Knob Operating

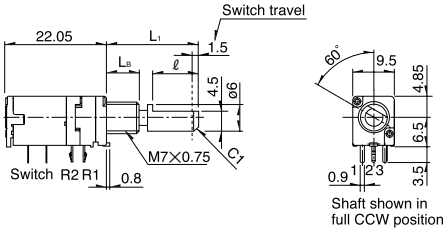
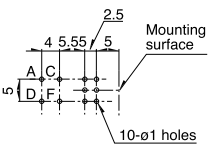
No.	Photo	Style	PC board mounting hole dimensions (Viewed from mounting side)												
1		<table border="1"> <tr><td>L<sub>1</sub></td><td>15</td><td>20</td><td>25</td></tr> <tr><td>L<sub>B</sub></td><td>5</td><td>7</td><td>10</td></tr> <tr><td>ℓ</td><td>7</td><td>12</td><td>12</td></tr> </table>  <p>Shaft shown in full CCW position</p>	L <sub>1</sub>	15	20	25	L <sub>B</sub>	5	7	10	ℓ	7	12	12	
L <sub>1</sub>	15	20	25												
L <sub>B</sub>	5	7	10												
ℓ	7	12	12												
2		<table border="1"> <tr><td>L<sub>1</sub></td><td>15</td><td>20</td><td>25</td></tr> <tr><td>L<sub>B</sub></td><td>5</td><td>7</td><td>10</td></tr> <tr><td>ℓ</td><td>7</td><td>12</td><td>12</td></tr> </table>  <p>Shaft shown in full CCW position</p>	L <sub>1</sub>	15	20	25	L <sub>B</sub>	5	7	10	ℓ	7	12	12	
L <sub>1</sub>	15	20	25												
L <sub>B</sub>	5	7	10												
ℓ	7	12	12												
3		<table border="1"> <tr><td>L<sub>1</sub></td><td>15</td><td>20</td></tr> <tr><td>L<sub>B</sub></td><td>5</td><td>7</td></tr> <tr><td>ℓ</td><td>7</td><td>12</td></tr> </table>  <p>Shaft shown in full CCW position</p>	L <sub>1</sub>	15	20	L <sub>B</sub>	5	7	ℓ	7	12	 			
L <sub>1</sub>	15	20													
L <sub>B</sub>	5	7													
ℓ	7	12													
4		<table border="1"> <tr><td>L<sub>1</sub></td><td>15</td><td>20</td></tr> <tr><td>L<sub>B</sub></td><td>5</td><td>7</td></tr> <tr><td>ℓ</td><td>7</td><td>12</td></tr> </table>  <p>Shaft shown in full CCW position</p>	L <sub>1</sub>	15	20	L <sub>B</sub>	5	7	ℓ	7	12	 			
L <sub>1</sub>	15	20													
L <sub>B</sub>	5	7													
ℓ	7	12													

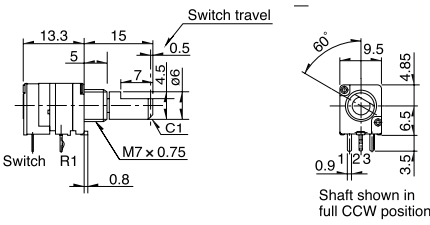
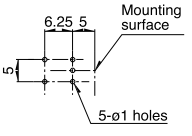
**Dimensions**

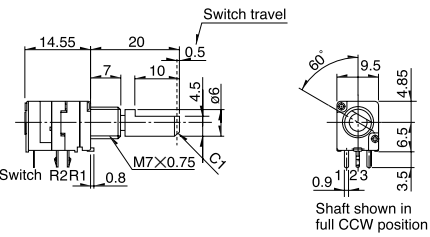
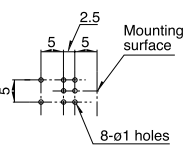
Unit:mm

No.	Photo	Style	PC board mounting hole dimensions (Viewed from mounting side)									
5	 <p><b>Single-shaft, single-unit with push-on push-off switch</b>                      RK0971112-5R2412</p>	<table border="1"> <tr><td>L<sub>1</sub></td><td>20</td><td>25</td></tr> <tr><td>L<sub>B</sub></td><td>7</td><td>10</td></tr> <tr><td>ℓ</td><td>10</td><td>12</td></tr> </table>  <p>Switch travel</p> <p>Switch R1</p> <p>Shaft shown in full CCW position</p>	L <sub>1</sub>	20	25	L <sub>B</sub>	7	10	ℓ	10	12	 
L <sub>1</sub>	20	25										
L <sub>B</sub>	7	10										
ℓ	10	12										
6	 <p><b>Single-shaft, dual-unit with push-on push-off switch</b>                      RK0971212-5R2412( For tone )                      RK0971222-5R2412( For vol. )</p>	<table border="1"> <tr><td>L<sub>1</sub></td><td>15</td><td>20</td></tr> <tr><td>L<sub>B</sub></td><td>5</td><td>7</td></tr> <tr><td>ℓ</td><td>7</td><td>10</td></tr> </table>  <p>Switch travel</p> <p>Switch R2 R1</p> <p>Shaft shown in full CCW position</p>	L <sub>1</sub>	15	20	L <sub>B</sub>	5	7	ℓ	7	10	 
L <sub>1</sub>	15	20										
L <sub>B</sub>	5	7										
ℓ	7	10										
7	 <p><b>Single-shaft, single-unit with momentary push switch travel 0.5mm</b>                      RK0971114-5R4211</p>	 <p>Switch travel</p> <p>Switch R1</p> <p>Shaft shown in full CCW position</p>	 									
8	 <p><b>Single-shaft, dual-unit with momentary push switch travel 0.5mm</b>                      RK0971214-5R4211( For tone )                      RK0971224-5R4211( For vol. )</p>	 <p>Switch travel</p> <p>Switch R2 R1</p> <p>Shaft shown in full CCW position</p>	 									

Rotary Potentiometers  
 Slide Potentiometers





Metal Shaft  
 Insulated Shaft  
 Knob Operating

**Dimensions**

Unit:mm

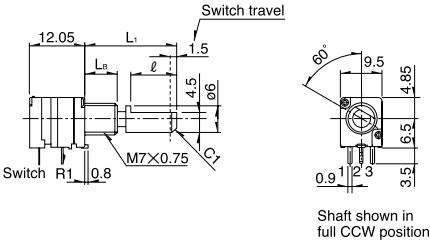
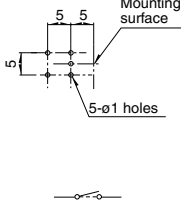

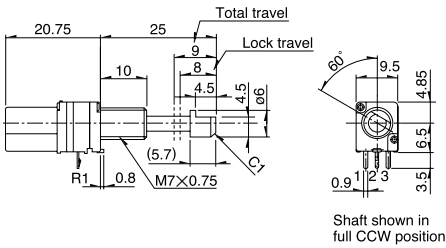
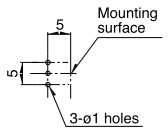
Rotary Potentiometers  
 Slide Potentiometers

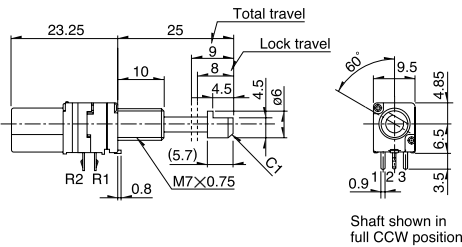
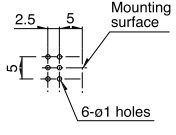
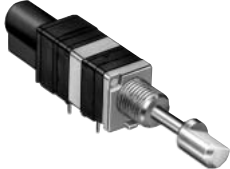
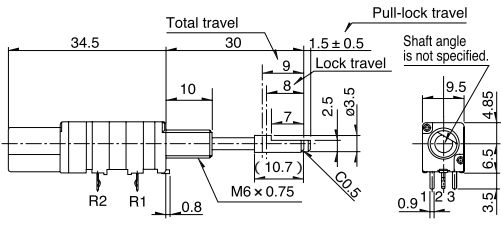
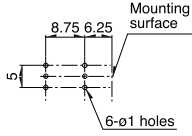
Metal Shaft  
 Insulated Shaft  
 Knob Operating

No.	Photo	Style	PC board mounting hole dimensions (Viewed from mounting side)									
9	<p><b>Single-shaft, single-unit with momentary push switch travel 1.5mm</b>                      RK0971114-5R4611</p> 	<table border="1"> <tr> <td>L<sub>1</sub></td> <td>20</td> <td>25</td> </tr> <tr> <td>L<sub>B</sub></td> <td>7</td> <td>10</td> </tr> <tr> <td>ℓ</td> <td>10</td> <td>12</td> </tr> </table> 	L <sub>1</sub>	20	25	L <sub>B</sub>	7	10	ℓ	10	12	
L <sub>1</sub>	20	25										
L <sub>B</sub>	7	10										
ℓ	10	12										
10	<p><b>Single-shaft, single-unit with push-lock mechanism</b>                      RK097111T</p> 											
11	<p><b>Single-shaft, dual-unit with push-lock mechanism</b>                      RK097121T (For tone)                      RK097122T (For vol.)</p> 											
12	<p><b>Single-shaft, dual-unit with push-lock mechanism and pull-lock mechanism</b>                      RK098122T</p> 											

**Dimensions**

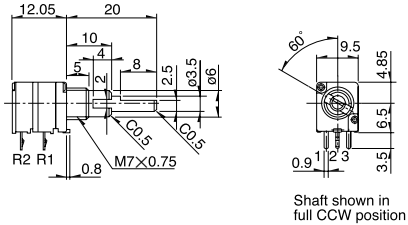
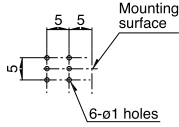
Unit:mm

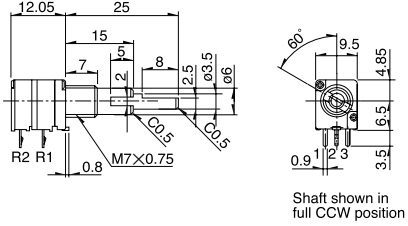
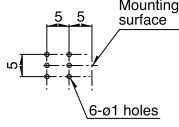
No.	Photo	Style	PC board mounting hole dimensions (Viewed from mounting side)
13			
14			

**Product Varieties**

In addition to the recommended products, the following specifications can also be accommodated.

**Dimensions of Terminal**

Unit:mm

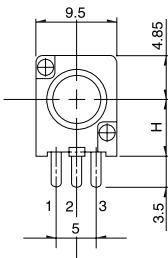
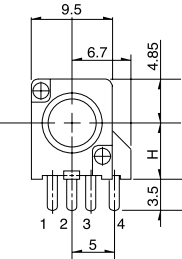
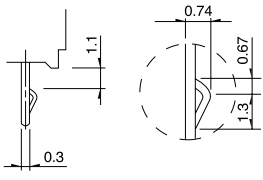
 <p>Outline drawing without tap</p>	 <p>Outline drawing with tap</p>	<p>Mounting height (H): 6.5mm(10mm and 12.5mm also available upon request.)                      For single-unit type with tap is only available with H=6.5mm.                      Tap is on the terminal 3 side only.</p>  <p>Detail of 2 terminal belong part</p>
--	---	--

**Dimensions of Bushings**

Unit:mm

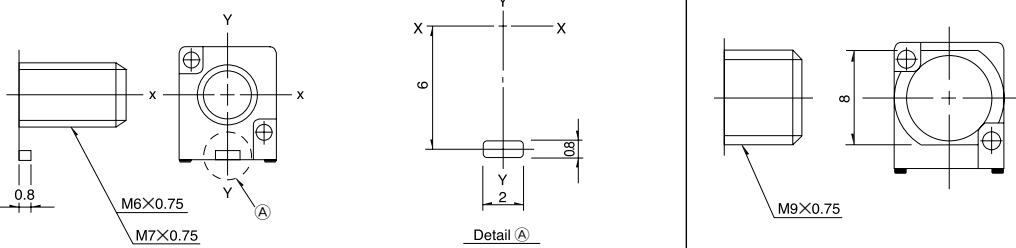
Bushing	M6	M7	M9
<p><b>Dimensions</b></p> 	<p><b>Applications</b></p> <p>For single-shaft only</p>	<p><b>Applications</b></p> <p>For single and dual-shaft</p>	<p><b>Applications</b></p> <p>For dual-shaft only</p>

## Product Varieties

In addition to the recommended products, the following specifications can also be accommodated.

### Total Resistance Variety

Total resistance(k )	10	20	50	100
----------------------	----	----	----	-----

### Resistance Taper

Resistance taper	15A	1B	3B	15C
------------------	-----	----	----	-----

### Note

Can be fitted with center-taps.

### Single-shaft Dimension

Flat type

Unit:mm

#### Style( Shaft diameter : 6 )

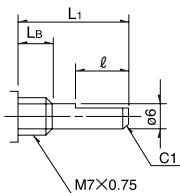

Shaft shown in full CCW position.

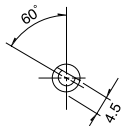

#### Detail dimensions

L <sub>1</sub>	L <sub>B</sub>	ℓ
15	5	7
20	7	12( 10 )
25	10	12
30	10	12

Models in parenthesis apply to those with a push-on switch and those with a push-on, push-off switch.

#### Style( Shaft diameter : 3.5 )

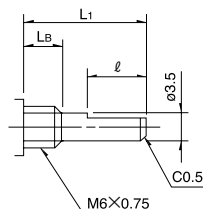

Shaft shown in full CCW position.

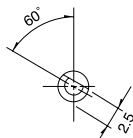

#### Detail dimensions

L <sub>1</sub>	L <sub>B</sub>	ℓ
15	5	7
20	7	12( 10 )
25	10	12
30	10	12

Models in parenthesis apply to those with a push-on switch and those with a push-on, push-off switch.

### Dimension of Dual-shaft Type

Applications Both switchless and rotary switch models are available.

Flat type for inner shaft, slotted type for outer shaft

Unit:mm

#### Style( Inner-shaft : 6 Outer-shaft : 8 )

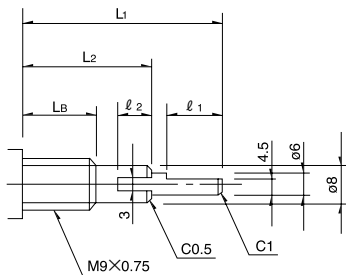

Shaft shown in full CCW position.

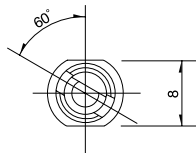

#### Detail dimensions

L <sub>1</sub>	L <sub>2</sub>	L <sub>B</sub>	ℓ <sub>1</sub>	ℓ <sub>2</sub>
20	10	5	8	4
25	15	7	8	5
30	20	10	8	5
35	25	10	8	5

#### Style( Inner-shaft : 3.5 Outer-shaft : 6 )

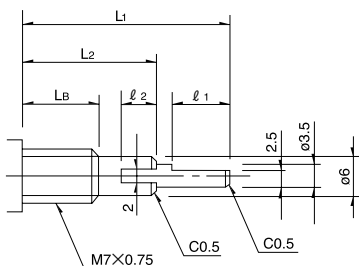

Shaft shown in full CCW position.

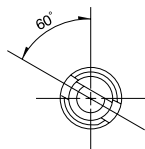

#### Detail dimensions

L <sub>1</sub>	L <sub>2</sub>	L <sub>B</sub>	ℓ <sub>1</sub>	ℓ <sub>2</sub>
20	10	5	8	4
25	15	7	8	5
30	20	10	8	5
35	25	10	8	5

### Note

marked are specifications recommended by ALPS.

Refer to P.338, 502 for resistance taper.



# Product Varieties

In addition to the recommended products, the following specifications can also be accommodated.

## Shaft Dimensions of with Push-lock Mechanism

Unit:mm

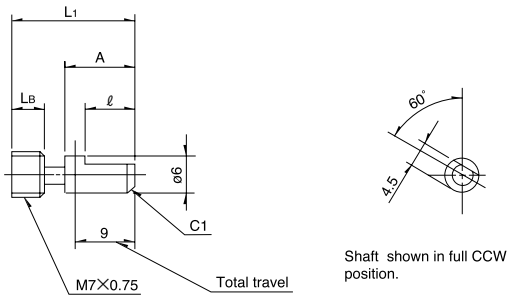

### Detail dimensions

$L_1$	$L_B$	$A$	$l$
25	10	( 5.7 )	4.5
30	10	( 10.7 )	7
35	10	( 15.7 )	12

Dimensions in unlocked state

### Example of uses

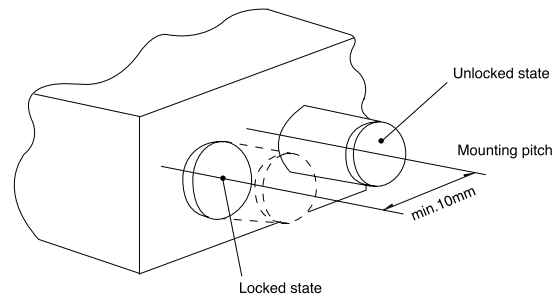
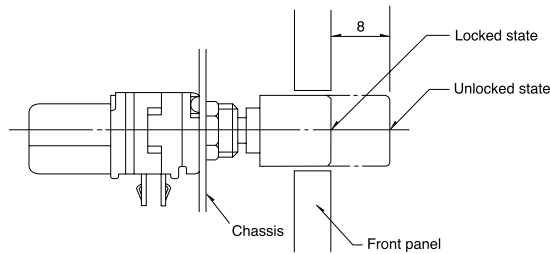

Rotary Potentiometers  
Slide Potentiometers

Metal Shaft  
Insulated Shaft  
Knob Operating

## Shaft Dimensions of with Push-lock Mechanism and with Pull-lock Mechanism

Unit:mm

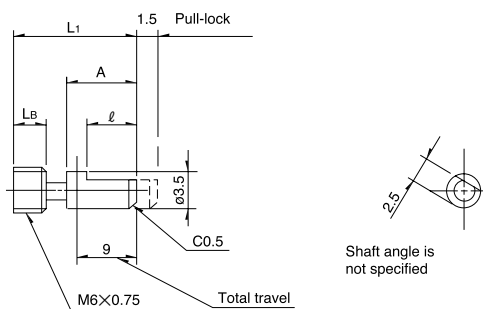

### Detail dimensions

$L_1$	$L_B$	$A$	$l$
25	10	( 5.7 )	4.5
30	10	( 10.7 )	7
35	10	( 15.7 )	12

Dimensions in unlocked state

### Example of uses

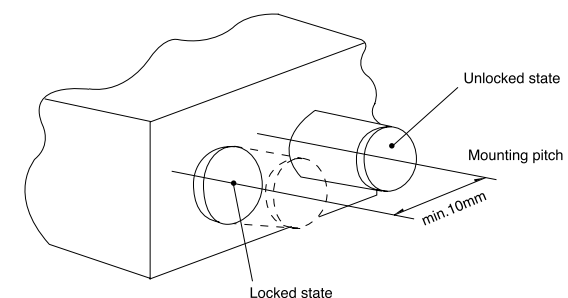
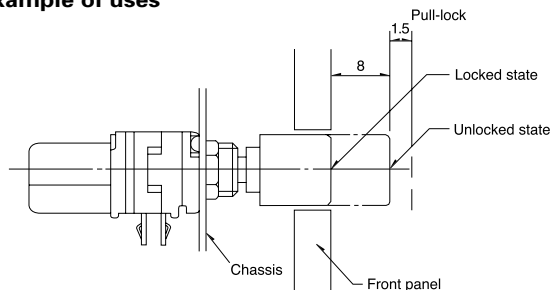

### Note

marked are specifications recommended by ALPS.

## Specification for Switches

### Mechanical Characteristics

Switch type		Pole-position	Rating	Operating force	Changeover angle (travel)
Rotary switch	5R1211	SPST	3A 16V DC	50mN·m max.	50 °max.
	5R1212	SPDT	1A 16V DC		
Push-on Push-off switch	5R2412		DPST	3A 16V DC	12 ± 8N
	5R2421				
Momentary push switch	5R4211	SPST	0.5A 12V DC	4 $\pm$ $\frac{1}{2}$ N	0.5mm
	5R4611			5 ± 2N	1.5mm

### Electrical Characteristics

Model	Contact resistance	Insulation resistance	Voltage proof
5R1211, 5R1212 5R2412, 5R2421 5R4211, 5R4611	100m $\Omega$ for initial period, 200m $\Omega$ after operating life	100M $\Omega$ min. Measured with a 250V DC insulation tester	300V AC 1 minute min.

### Durability

Operating life under load	5R1211,5R1212 5R2412,5R2421 5R4211	The switch under a rated resistance load shall be subjected to a total of 10,000 cycles of operation at a speed of 600 to 1,000 cycles per hour. The contact resistance after testing should not exceed 200m $\Omega$ .
	5R4611	The switch under a rated resistance load shall be subjected to a total of 20,000 cycles of operation at a speed of 600 to 1,000 cycles per hour. The contact resistance after testing should not exceed 200m $\Omega$ .

### Note

The operating current should be 10mA or greater.

Rotary  
PotentiometersSlide  
PotentiometersMetal  
ShaftInsulated  
ShaftKnob  
Operating

# Configuration Chart

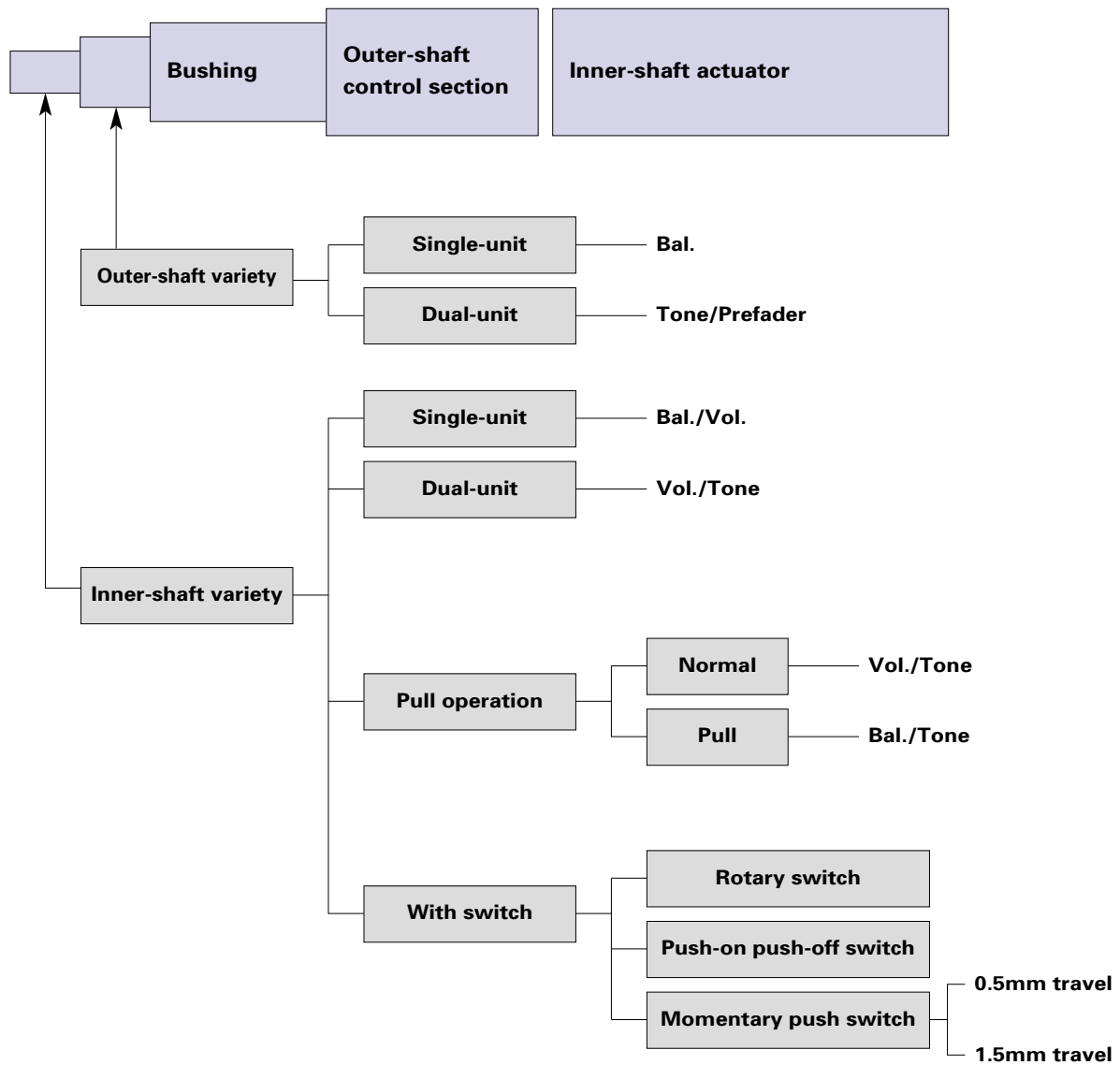

Rotary Potentiometers  
Slide Potentiometers

Metal Shaft  
Insulated Shaft  
Knob Operating

**Note**

The single-shaft type product lineups are the same as those in the inner-shaft variety.

# Orders Other Than Recommended Products

When ordering product varieties that are not listed in the Product Line, please specify by referring to the below example.

## Sample Part Number



### Model type

Code	Model type
111	Single-shaft single-unit
121	Single-shaft dual-unit for tone
122	Single-shaft dual-unit for vol.

### Switch specifications

Code	Switch specifications
0	Without switch
1	With rotary switch
2	With push-on push-off switch
4	With momentary push switch(0.5mm travel)
T	With push-lock mechanism

\*Push on switch 1.5mm stroke is individually specified.

### Shaft type

Code	Shaft type
F	Flat (shaft diameter : 6)

\*Shaft diameter 3.5 is individually specified.

### Length of the shaft (L: X mm)

Code	Length of the shaft	Code	Length of the shaft
15	15	25	25
20	20	30	30

### Detent

Code	Detent	Code	Detent
C0	Without	11	11
C1	Center	31	31

### Resistance taper

Code	Resistance taper	Code	Resistance taper
A	15A	V	3B
B	1B	C	15C

\*The resistance taper for rotary switches are individually defined.

B:For tone & general(model type : 111,121)  
V:For vol.(model type : 111,122)

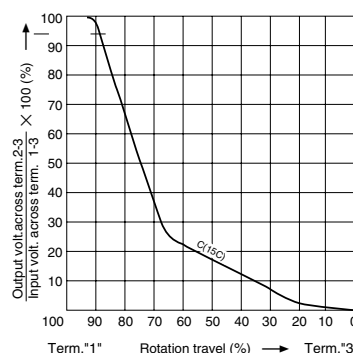
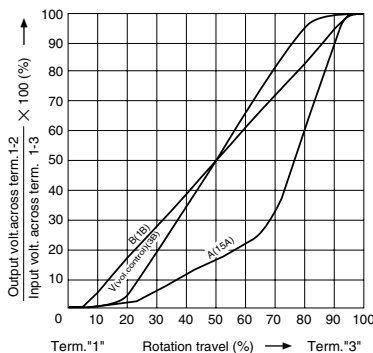

### Total resistance

Code	Total resistance (kΩ)	Code	Total resistance (kΩ)
103	10	503	50
203	20	104	100

### Notes

1.   marked are specifications recommended by ALPS.
2. The above specification is only applicable to the one-shaft single-unit model and dual-unit ganged model.







Rotary Potentiometers  
Slide Potentiometers

Metal Shaft  
Insulated Shaft  
Knob Operating

## List of Varieties

Rotary Potentiometers  
Slide Potentiometers

Metal Shaft  
Insulated Shaft  
Knob Operating

Type	9mm size metal shaft snap-in	9mm size metal shaft multi-ganged	11mm size metal shaft low-profile	11mm size metal shaft reflow	16mm size metal shaft	
Number of drive shafts	Single-shaft		Dual-shaft	Single-shaft		
Model	RK09L1	RK0971 RK0981	RK0972	RK117111	RK119	RK1631 1 RK1631 A
Photo						
Fixing method of bushing	The bushing can be screwed down		Bushing screw clamp	Bushing guide type		
Terminal mounting	Horizontal type	Vertical type	Horizontal type	Vertical type		
Attached switch	Without		Rotary switch 1	Momentary push switch		Without
			Push-on push-off switch 1			
			Momentary push switch 1			
Gang error applicable to Dual-unit parts for audio volume control purposes	- 40dB to 0dB 3dB max.		—————		- 40dB to 0dB 3dB max.	
Solder heat resistance	Manual soldering	350 max. 3s max.			350 ± 10 3 <sup>+1</sup> / <sub>0</sub> s	350 max. 3s max. Motor terminal: 360 max 2s max.
	Dip soldering	260 ± 5 , 5 ± 1s			—————	
	Reflow soldering	—————			Please see P.347	—————
Operating temperature range	- 10 to + 70	- 20 to + 70	- 30 to + 70	- 40 to + 85	- 10 to + 70	
Electrical performance	Rated power	0.05W				
	Residual resistance	10k < R < 50k 50k < R	20 max. 30 max. Nominal total resistance of 0.1% or less		R 10k 50 max. 10k < R 50k 80 max. 50k < R Nominal total resistance of 0.2% or less	R 10k 20 max. 10k < R 50k 30max. 50k < R Nominal total resistance of 0.1% or less
	Maximum attenuation (Volume control)		5k R < 10k 10k R < 50k 50k R < 100k 100k R	70dB min. 80dB min. 90dB min. 100dB min.		
	Insulation resistance	100M min. 250V DC				100M min. 500V DC
	Voltage proof	300V AC for 1minute				500V AC for 1minute
Mechanical performance	Stopper strength	0.5N·m( With push-lock mechanism type: 0.4N·m )			0.5N·m	0.9N·m
	Push-pull strength	80N max.	100N max.			
	Vibration	10 to 55 to 10Hz/min., the amplitude is 1.5mm for all the frequencies, in the 3 direction of X, Y and Z and for 2 hours respectively				
Environmental performance	Cold	- 20 ± 2 for 96h	- 30 ± 2 for 96h		- 40 ± 2 for 240h	- 20 ± 2 for 96h
	Dry heat	70 ± 2 for 96h			85 ± 2 for 240h	70 ± 2 for 96h
	Damp heat	40 ± 2 , 90 to 95%RH for 96h			60 ± 2 , 90 to 95%RH for 240h	40 ± 2 , 90 to 95%RH for 96h
Page	323	327	339	343	348	

### Push-on Switch Specifications

Items	RK097		RK117		RK119	
Contact arrangement	Single pole and single throw ( Push on )					
Travel( mm )	0.5	1.5	0.5	1.5	0.5 ± 0.3	1.5 ± 0.5
Operating force ( N )	4 <sup>+1</sup> / <sub>2</sub>	5 ± 2	6 ± 3	5 ± 2		4 ± 2
Rating	0.5A 12V DC		3A 16V DC		0.1A 5V DC (1mA 5V DC min.ratings)	
Contact resistance	100m for initial period;200m after operating life					
Operating life	10,000 times min.	20,000 times min.	10,000 times min.	20,000 times min.	100,000 times min.	20,000 times min.

Metal Shaft Potentiometers Attached Parts .....363  
Metal Shaft Potentiometers Cautions .....364, 365

### Notes

1. For the switch attached, the single-shaft or inner shaft of the dual-shaft type can be chosen.
2. The operating temperature range for automotive applications can be raised upon request. Please contact us for requirements of this kind.

## Attached Parts

The following parts are included with the product.

Unit:mm

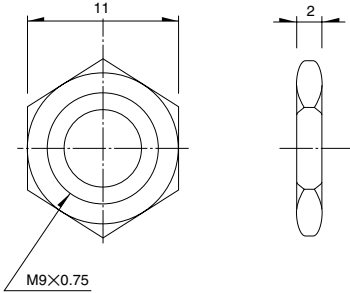
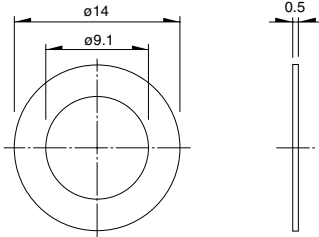
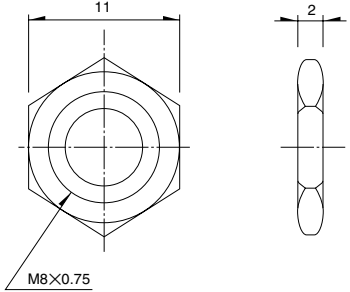
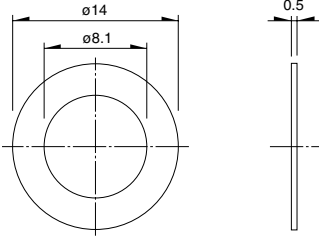
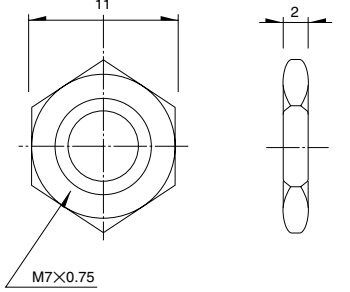
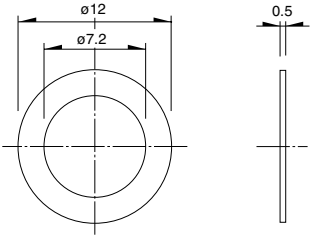
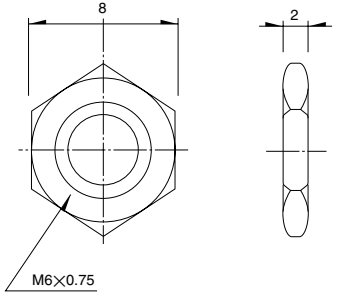
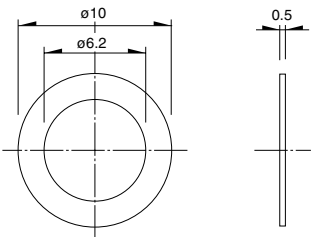
Applicable products	Bearing screw diameter	Hexagonal nut	Flat washer
<p>RK09L RK168 RK097 RK203</p>	<p>M9</p>		
<p>RK271</p>	<p>M8</p>		
<p>RK097 RK098 RK163</p>	<p>M7</p>		
<p>RK097 RK098</p>	<p>M6</p>		

Rotary  
Potentiometers  
Slide  
Potentiometers

Metal  
Shaft  
Insulated  
Shaft  
Knob  
Operating